

LED Sports Lighting



SP06C

- ❁ Sufficient for UL cUL certificate
- ❁ Wattage adjustable
- ❁ No UV or IR in the beam
- ❁ Easy to install and operate
- ❁ Energy saving, long lifespan
- ❁ Instant start, NO flickering, NO humming
- ❁ Green and eco-friendly without mercury
- ❁ Output constant current lever can be adjusted through output cable with 0-10V.



Specifications

Power(W)	Input Voltage(V)	Delivered Lumens (lm)	Efficacy (lm/W)	CRI	Beam Angle	Available CCT	Operating Temp	IP Rating	Weight (kg)
450		72000-81000	150-170	Ra>70	20°, 30°, 40°, 60°, 120°		-40°~45°C	IP66	16
600	120-277/200-480	96000-108000	150-170	Ra>70	20°, 30°, 40°, 60°, 120°	4000K/4500K/	-40°~45°C	IP66	16.2
800	100-240/220-415	128000-144000	150-170	Ra>70	20°, 30°, 40°, 60°, 120°	5000K/5700K	-40°~45°C	IP66	23
1200		192000-216000	150-170	Ra>70	20°, 30°, 40°, 60°, 120°		-40°~45°C	IP66	27

Dimension

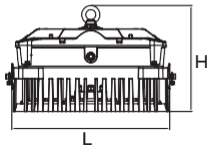

Power(W)	Φ	L	H
450/600	14.8"/375mm	15.1"/385mm	12.1"/308mm

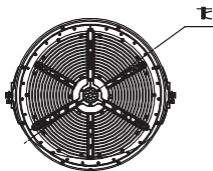

800	19.1"/484mm	19.6"/498mm	13.1"/333mm
1200	21.3"/542mm	22.2"/564mm	14.4"/365mm

Blank

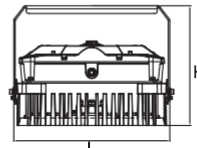

Power(W)	Φ	L	H
450/600	14.8"/375mm	15.5"/394mm	13"/330mm

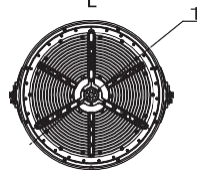

800	19.1"/484mm	20.1"/510mm	15.4"/390mm
1200	21.3"/542mm	22.6"/575mm	17"/432mm

FM2

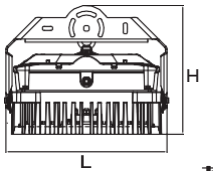

Power(W)	Φ	L	H
450/600	14.8"/375mm	16.5"/419mm	13.7"/348mm

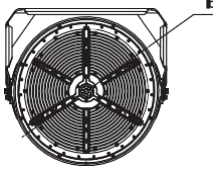

800	19.1"/484mm	20.7"/525mm	16.5"/420mm
1200	21.3"/542mm	22.6"/575mm	17.5"/445mm

FM1

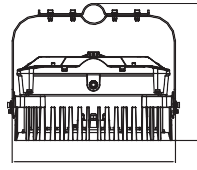

Power(W)	Φ	L	H
450/600	14.8"/375mm	15.5"/394mm	14.4"/367mm

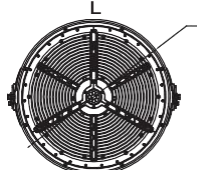

800	19.1"/484mm	20"/508mm	16.8"/425mm
1200	21.3"/542mm	22.6"/574mm	19.5"/495mm

AM

Installation Diagram

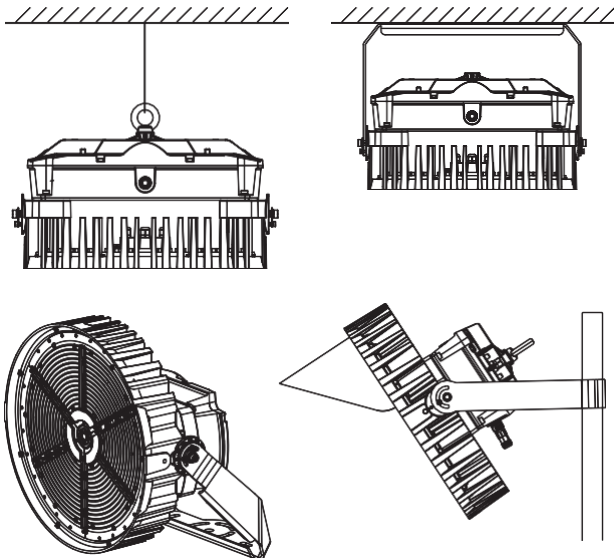

Distribution Diagram

