

INTEGRATED LOW VOLTAGE DAYLIGHT HARVESTING/BI-LEVEL PIR MOTION SENSOR



IFS105S



IFS105SE



FEATURES

- Lumenativ IFS105S/SE series are designed for Luminaire Level Lighting Control (LLC/NLC5) with integrated daylight harvesting and PIR motion sensors.
- Easy to Install
- Requires dim to off luminaire driver
- Digital Sensor equipped

DIMENSION

Unit: inch/mm

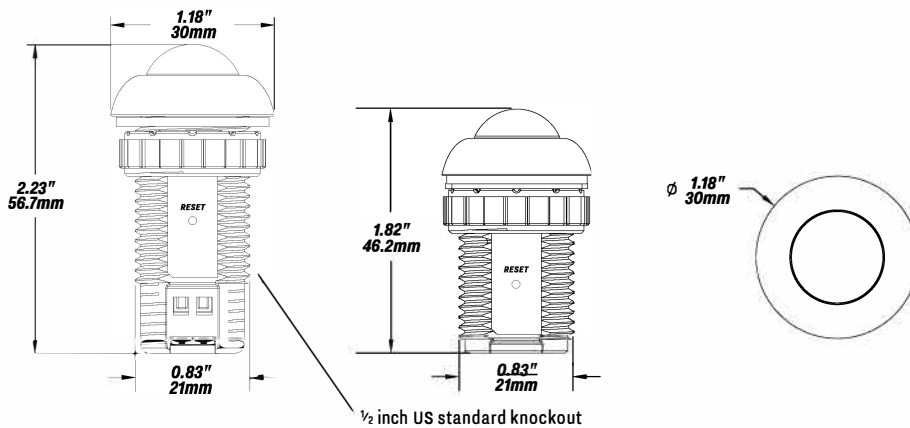

AMERICAN INCH PRODUCTS		
Size	T.P.I	Major Dia.
R1/2	14	0.825

SPECIFICATIONS

- Input Voltage: DC 12V
- Output Current: 10mA Max
- Output Power: 0.1W
- Dimming: Class 2, 0-10V DC 10mA Max
- Sinking Current: 10mA Max
- Bluetooth Transmit: 100ft Max
- Radio Frequency: 2.4GHz ± 75MHz
- Bluetooth Version: 4.2
- Housing Material: UL 94-5VA, Indoor Use Only
- Detection Range: 40ft Max
- Mounting Height: 18ft Max
- Operating Temperature: -30°C to 55°C, -22°F to 131°F
- Storage Temperature: -30°C to 85°C, -22°F to 185°F
- IP Rating: IP20
- Color: White
- Warranty: 5 years warranty
- Comply to UL8750, UL1376, RoHS
- Safety: cULus Listed LED Controller E504054
- FCC ID: 2A26YLTkTVT2021
- DID: D057145
- DLC: NLTRC5KLOTN

MODEL	DESCRIPTION
IFS105S	Fixture Sensor
IFS105SE	Fixture Sensor for low profile luminaire

WIRING

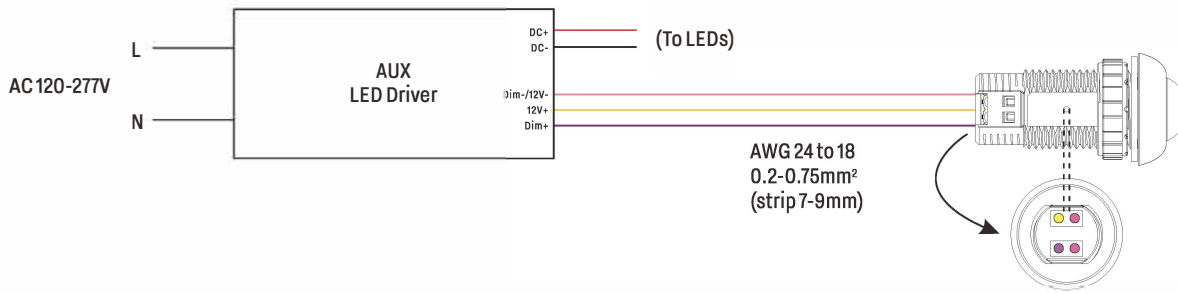
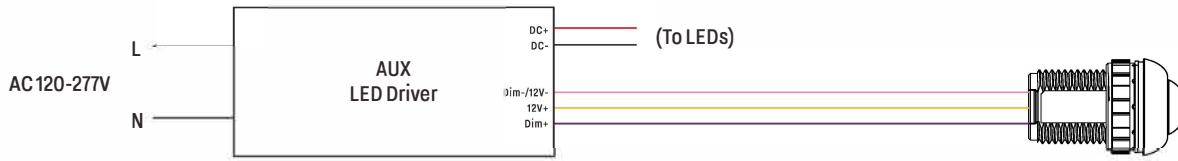

DIMENSION

Unit: inch/mm

LBL1

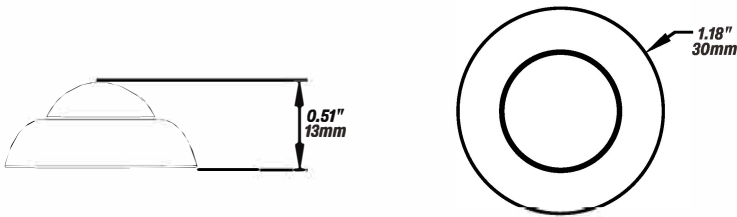

Coverage Side View

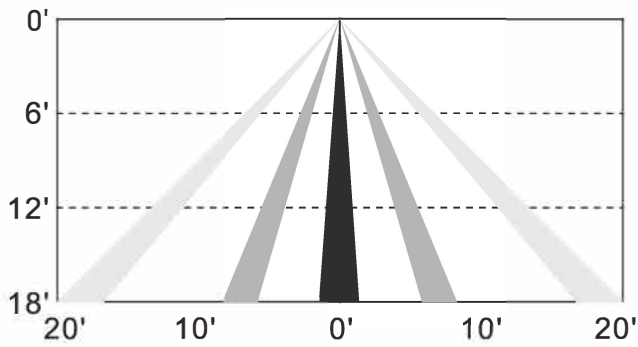

Coverage Top View

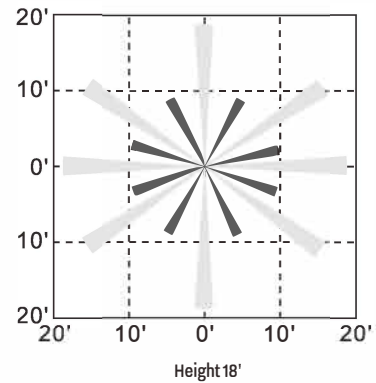

DIMENSION

Unit: inch/mm

LBL2



Coverage Side View

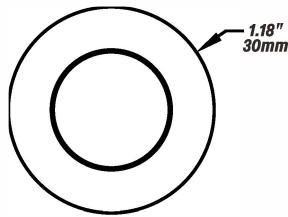

Coverage Top View

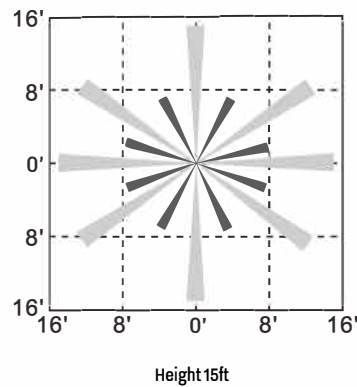
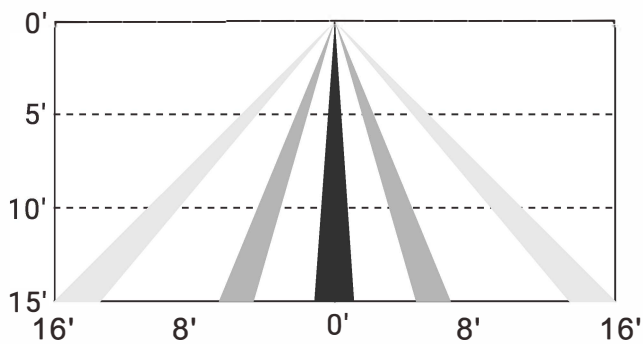

Height 15ft

MARKING

LUMENATIV
IFS105S Low bay sensor
Bluetooth
FCC ID:2A26YLTkTVT2021



Install Guide





LUMENATIV
IFS105SE Low bay sensor
Bluetooth
FCC ID:2A26YLTkTVT2021



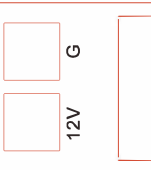

Install Guide

Input: Class 2, CV, 12VDC, 8mA, 0.1W.
Output: Class 2, 10VDC, 10mA max, 0.1W.
Damp location,
0-10V dimming,

LUMENATIV

Input: Class 2, CV, 12VDC, 8mA, 0.1W.
Output: Class 2, 10VDC, 10mA max, 0.1W.
Damp location,
0-10V dimming,

LUMENATIV

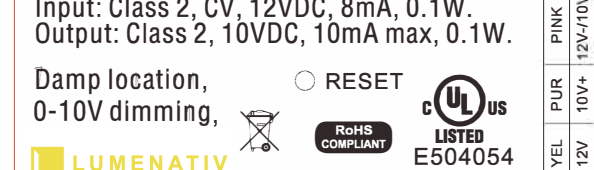
APP DOWNLOAD

