

# External High Bay Sensor



## FEATURES

The Lumenativ AC High Bay PIR Sensor and Controller EFS104 is compatible to other Lumenativ Devices which utilizes Bluetooth technology for reliable and secure wireless communication. EFS104 has been equipped **AlgoH™** algorithm to maximum the detection range up to 40ft high without false trigger.

- Design for High Bay applications
- AlgoH algorithm enhance performance in high bay application
- Analog Sensor Built-in
- Replaceable lens options
- 120-277V Line Voltage input
- Daylight Harvesting Available

## DIMENSION

Unit: inch/mm

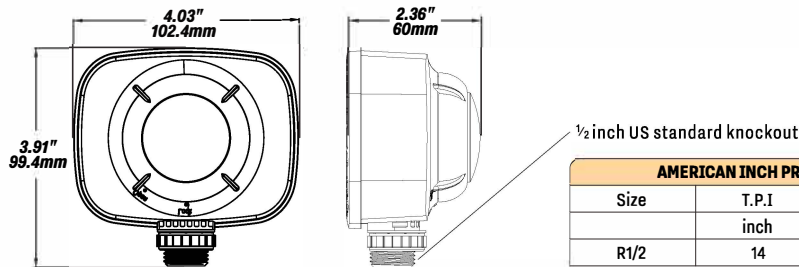

AMERICAN INCH PRODUCTS		
Size	T.P.I	Major Dia.
R1/2	14	0.825

### Extension Adapter (Optional)

**EJ30**

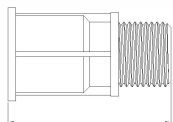

2.03"  
51.5mm

**EJ50**

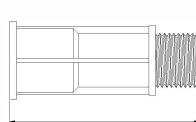

2.81"  
71.5mm

MODEL	DESCRIPTION
EFS104	External Bluetooth Network Wireless High Bay Sensor and Fixture Controller
HBL1-2-W	HBL1 High Bay Lens
HBL2-2-W	HBL2 High Bay Lens
MBL1-2-W	MBL1 Middle Bay Lens
EJ30	Extension Adapter
EJ50	Extension Adapter

## SPECIFICATIONS

Input Voltage: AC120-277V

Frequency: 50/60Hz

Input Current: 10A Max @ 120V,  
4.3A Max @ 277V

Input Power: 1200W Max

Output Voltage: AC120-277V

Output Current: 10A Max @ 120V,  
4.3A Max @ 277V

Output Power: 1200W Max

Dimming: Class 2, 0-10V DC 10mA Max

Sinking Current: 10mA Max

Bluetooth Transmit: 200ft Max

Radio Frequency: 2.4GHz ± 75MHz

Bluetooth Version: 4.2

Housing Material: UL 94-5VA

Detection Range: 40-80ft

Mounting Height: 20-40ft

Indoor/Outdoor Use

Operating Temperature: -30°C to 55°C,  
-22°F to 131°F

Storage Temperature: -30°C to 85°C,  
-22°F to 185°F

IP Rating: IP66

Color: White

Warranty: 5 years warranty

Comply to UL8750, UL1376, RoHS

Safety: cULus Listed LED Controller  
E504054

FCC ID: 2A26YLTKTVT2021

DID: D057145

DLC: NLTRC5KL0TN

**WIRING**

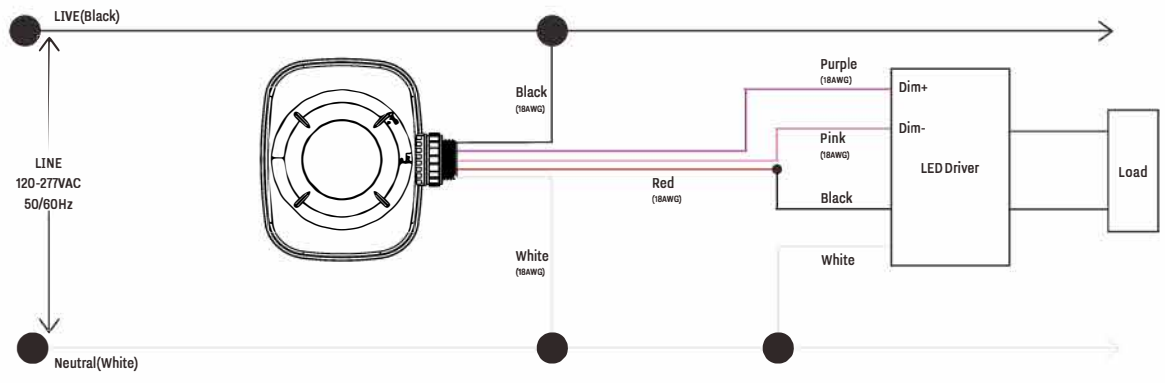

**DIMENSION**

**HBL1**

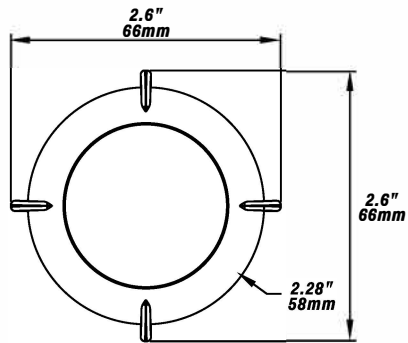
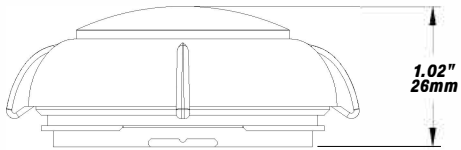

**Coverage Side View**

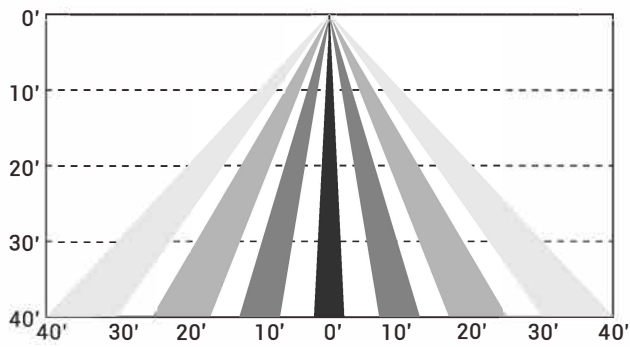

**Coverage Top View**

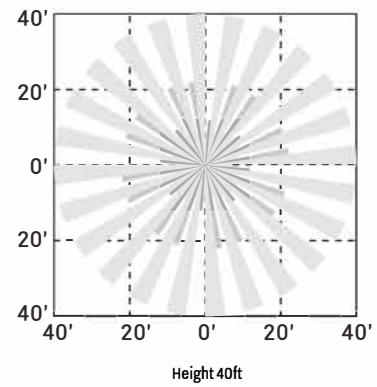

Height 40ft

**DIMENSION**

**HBL2**

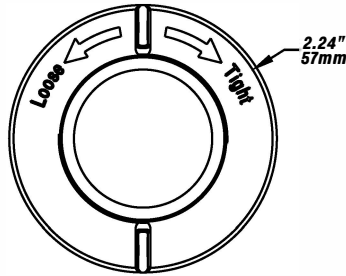
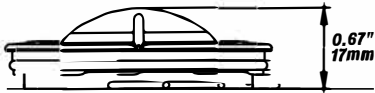

**Coverage Side View**

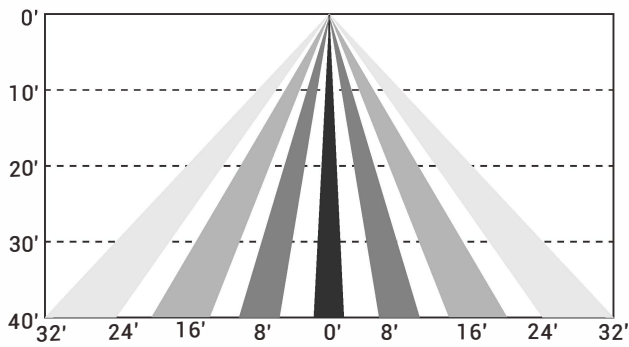

**Coverage Top View**

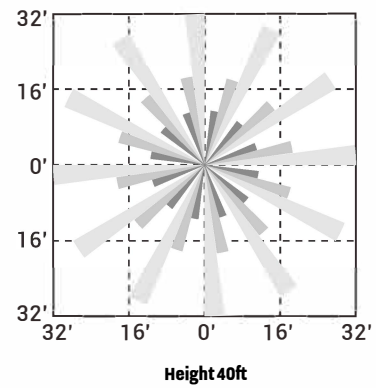

**MBL1**

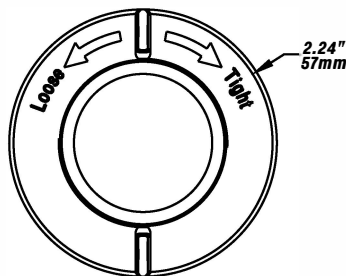
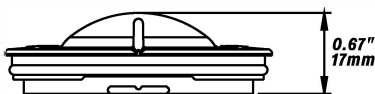

**Coverage Side View**

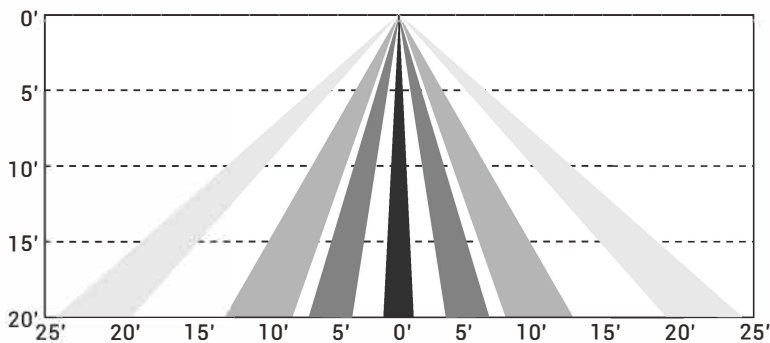

**Coverage Top View**

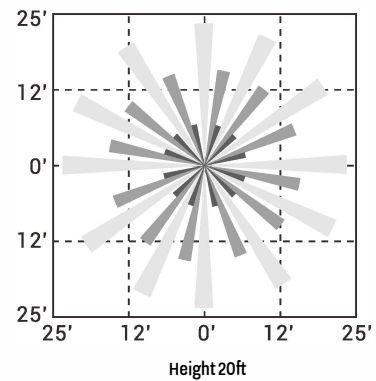

**MARKING**

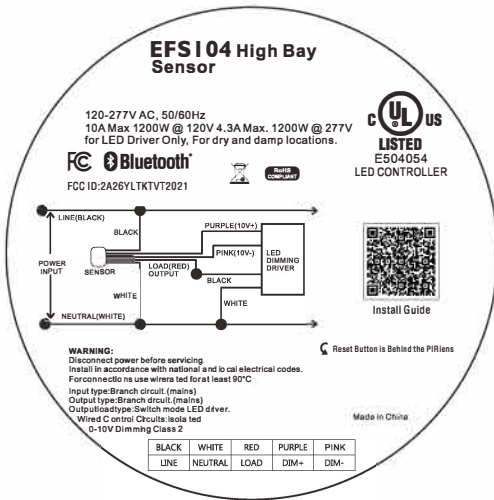

The Bluetooth word mark and logos are registered trademarks owned by Bluetooth SIG, Inc. and any use of such marks by Litetrace is under license. Other trademarks and trade names are those of their respective owners.

**APP DOWNLOAD**

